

Vehicle Model Forte  
 Model Year 2014~  
 Part Number A7024 ADU00

Accessory Hood Deflector  
 Difficulty (B)

Note: Difficulty stated above reflects the minimum level of expertise required to install the accessory  
 ( A ) Customer ( B ) Dealer Technician ( C ) Master Technician

Instructional Symbols / Definitions

	Denotes warnings that may lead to serious physical injury or vehicle damage.		Denotes quality processes to be checked prior to moving to the next step.	Denotes safety equipment required to be used such as a mask, goggles, rubber gloves, and hearing protection.	
	Denotes cautions to be taken to avoid physical injury or electronic component damage.		Denotes specific tools that are necessary to complete the step.		
	Denotes cautions to be taken to avoid vehicle and component damage.	<b>NOTE</b>	Denotes instructional steps necessary to complete the process.		
				Mask	Goggles
				Rubber Gloves	Hearing Protection

Basic Required Hand Tools

#2 Phillips Screwdriver	Soap & Water	Clean Dry Cloth	Non-Permanent Marker or Pencil

Notes to the Installer :

- Read the entire installation pamphlet prior to beginning the installation of the accessory.
- Ensure that the vehicle is properly protected in the area that the accessory is to be installed.
- To prevent vehicle damage, never place tools on top of painted surfaces, seats, dash pad, console or floor carpet / mat.
- Always wear appropriate safety gear to include gloves and eye protection when required.

# KIA Genuine Accessories

## Kit Overview

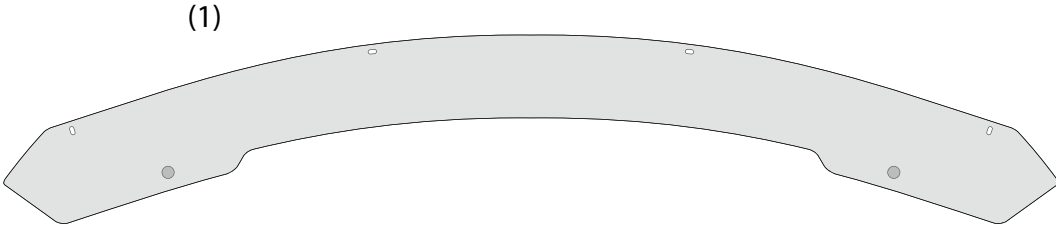

(1)





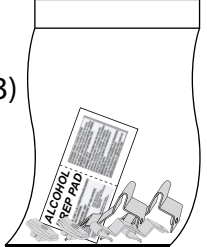

(2)

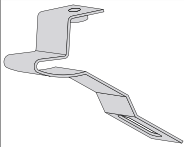
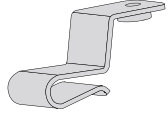
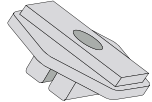
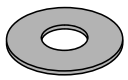

(3)

No.	Qty.	Description
1	1	<b>HOOD DEFLECTOR</b>
2	1	<b>I-SHEET</b>
3	1	<b>HARDWARE KIT</b>

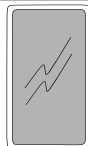
## Hardware Overview

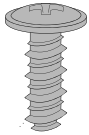
A		B		C		D		E	
2	Alcohol Prep Pad	2	Center Fixed Clip	2	Wing Clip	2	Screw Plug	2	Large Washer
F		G		H		I		J	
4	Small Washer	2	Small Abrasive Resistant Tape	4	Large Abrasive Resistant Tape	4	Small Screw	2	Self Tapping Screw

Hardware Kit Total
26

# KIA Genuine Accessories

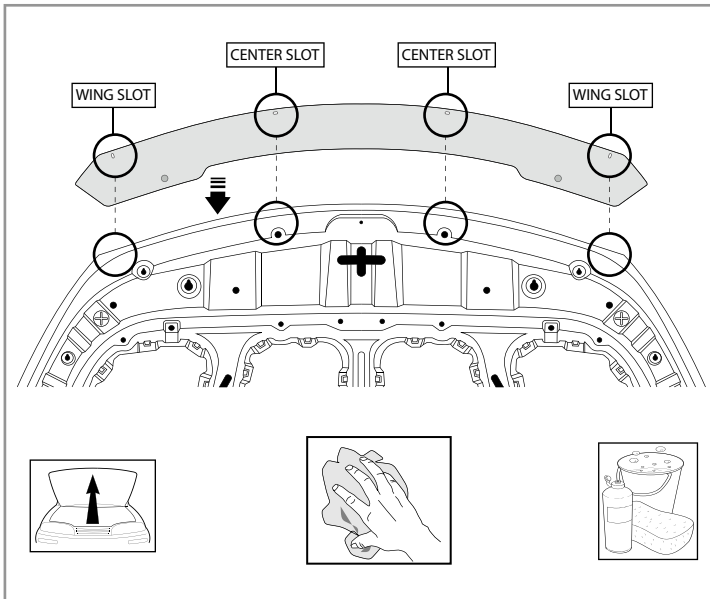

**1** Soap and Water, Clean Dry Cloth, and a Non-Permanent Marker or Pencil

**NOTE** Thoroughly clean and dry the hood prior to installation. Open the hood and trial fit the Hood Deflector centrally onto hood. With a non-permanent marker or pencil, mark the holes on the underside of the hood that correspond with the two (2) center slots in the Hood Deflector. Also mark the two (2) wing slot positions in relation to the hood lip with a non-permanent marker or pencil. Remove the Hood Deflector.

Make sure all surfaces are completely dry before proceeding to the next step.

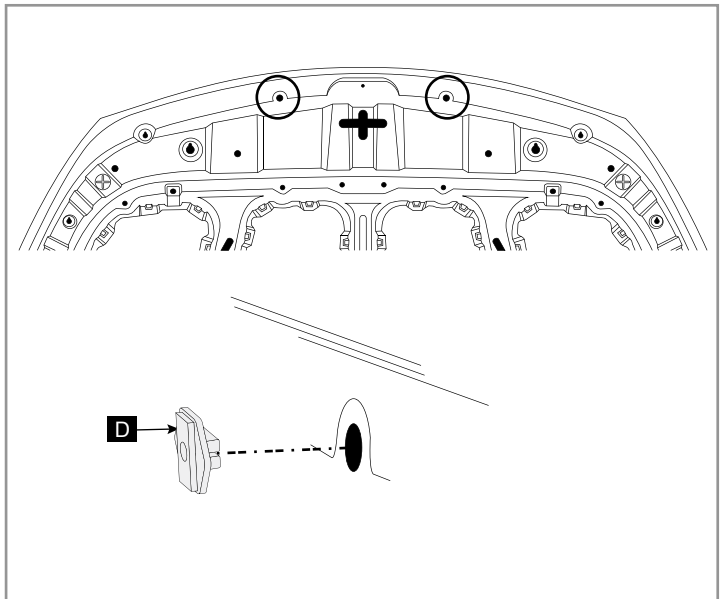

**2**

**NOTE** Insert the two (2) provided screw plugs "D" into the two (2) vacant holes of the hood as shown.

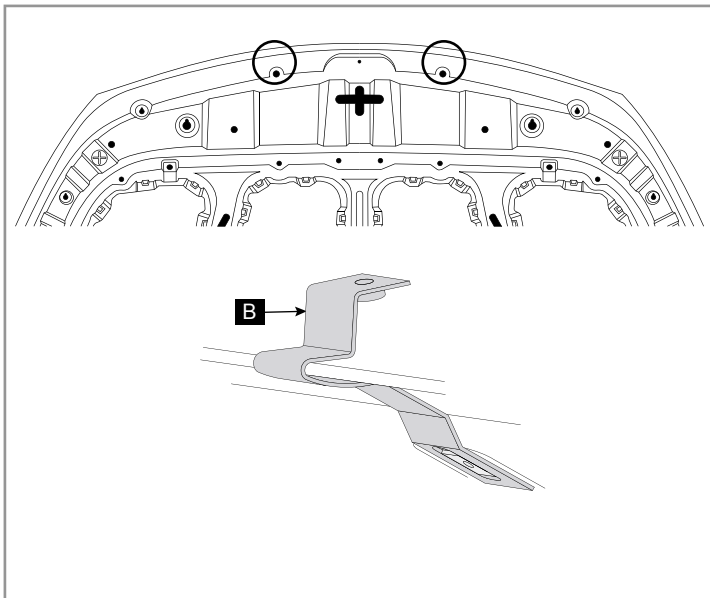

**3** Non-Permanent Marker or Pencil

**NOTE** Trial fit the two (2) center fixed clips "B" aligning the rectangular holes in the clips with the holes in the hood. With a non-permanent marker or pencil mark where the clips make contact with the hood areas, and then remove the clips.

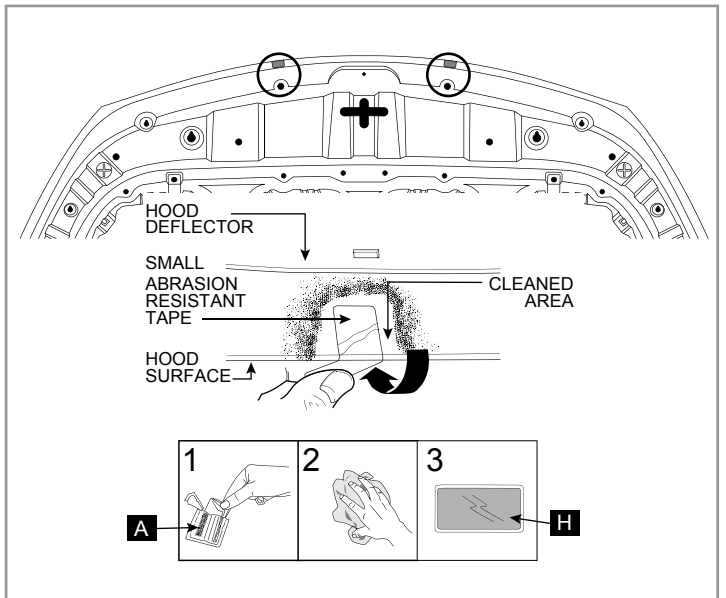



**4** Clean Dry Cloth

**NOTE** Clean the previously marked center clip locations with the alcohol prep pad provided. Wipe off any residue with a clean dry cloth. Adhere two (2) of the large abrasive resistant tape strips "H" over the hood lip. Apply tape so approximately one third of the strip is adhered to the top side and two thirds is adhered to the underside of hood.

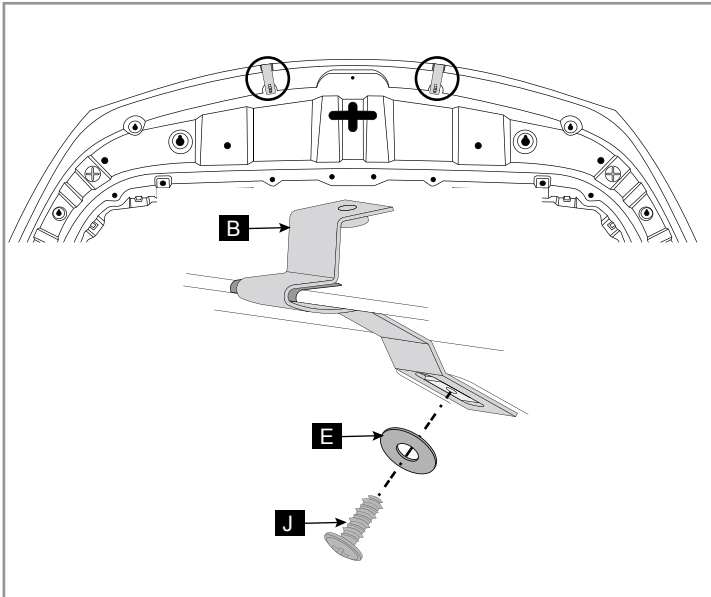

Ensure abrasive resistant tape strips are evenly distributed on the edge of the hood to prevent metal clips from having direct contact with the paint.

# KIA Genuine Accessories



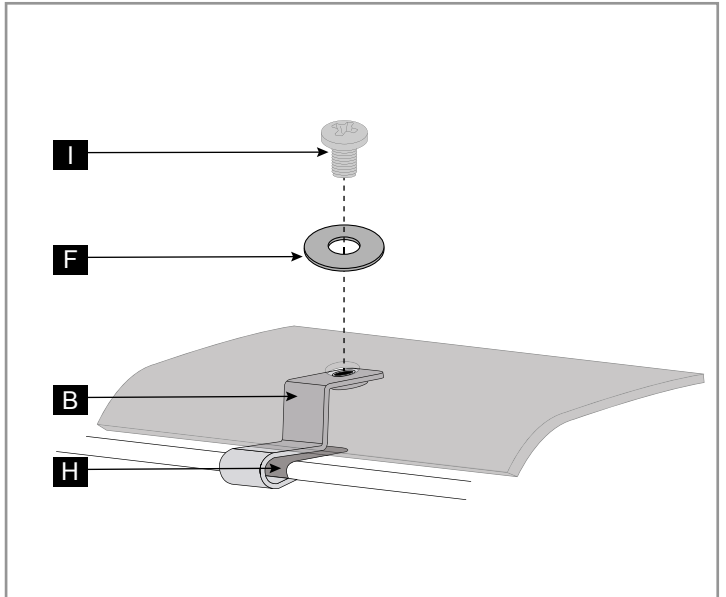

	#2 Phillips Screwdriver	<b>5</b>
<b>NOTE</b>	Re-fit the two (2) center fixed clips "B" aligning the rectangular holes in the clips with the previously installed screw plugs "D". Insert the two (2) self tapping screws "J" through the two (2) washers "E" into the two (2) screw plugs "D", as shown. Make sure that the clips rest on the abrasive resistant tapes.	
	Ensure metal clips are positioned over abrasive resistant tape strips preventing direct contact with the paint. Failure to do so may result in permanent paint damage.	



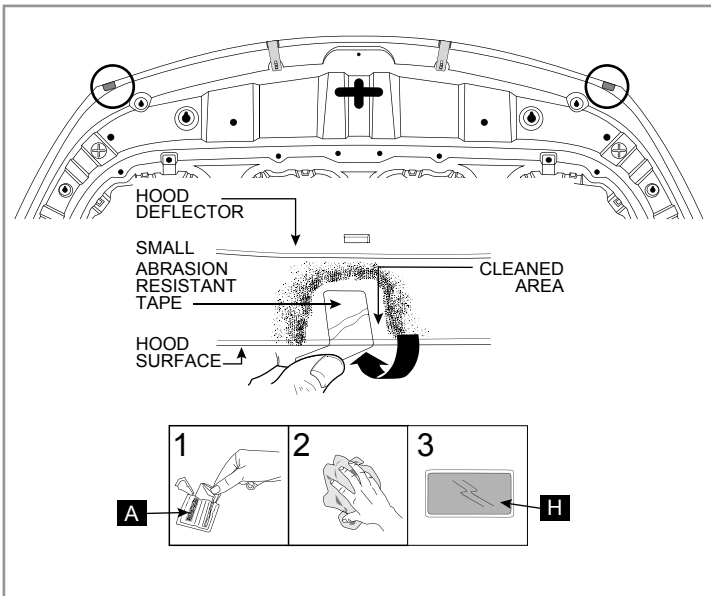

	#2 Phillips Screwdriver	<b>6</b>
<b>NOTE</b>	Remove the protective film from the Hood Deflector. Fit the Hood Deflector centrally to hood and loosely secure to the top of center fixed clips "B" with two (2) of the small screws "I" and two (2) of the small washers "F" provided.	
	Only use moderate tension when securing the screws as to allow the hood deflector slight movement.	



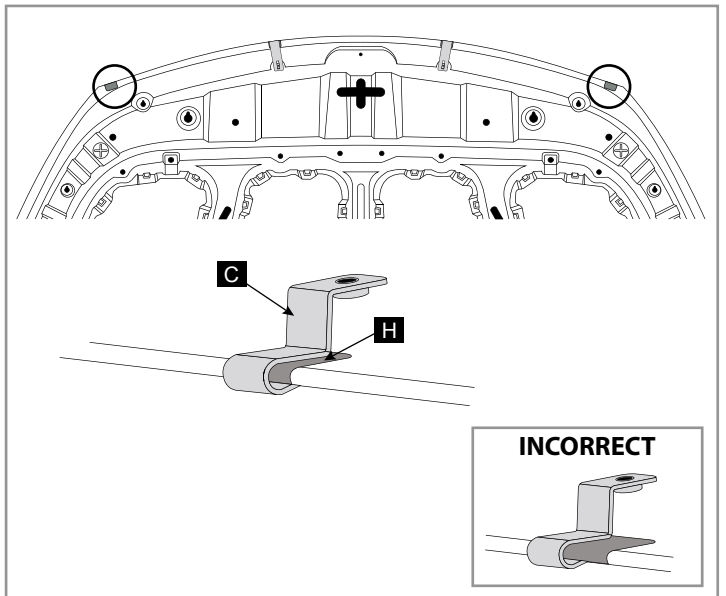

		<b>7</b>
<b>NOTE</b>	Clean the two (2) marked areas under the wing clip locations with alcohol prep pad provided. Wipe off any residue with a clean dry cloth. Align the large abrasive resistant tape "H" so that center of tape is aligned with wing clip screw hole in deflector. Apply the large abrasive resistant tape "H" so that approximately one third of the strip is adhered to the top side and two thirds is adhered to the underside of the hood.	
	Ensure abrasive resistant tape strips are evenly distributed on the edge of the hood to prevent metal clips from having direct contact with the paint.	



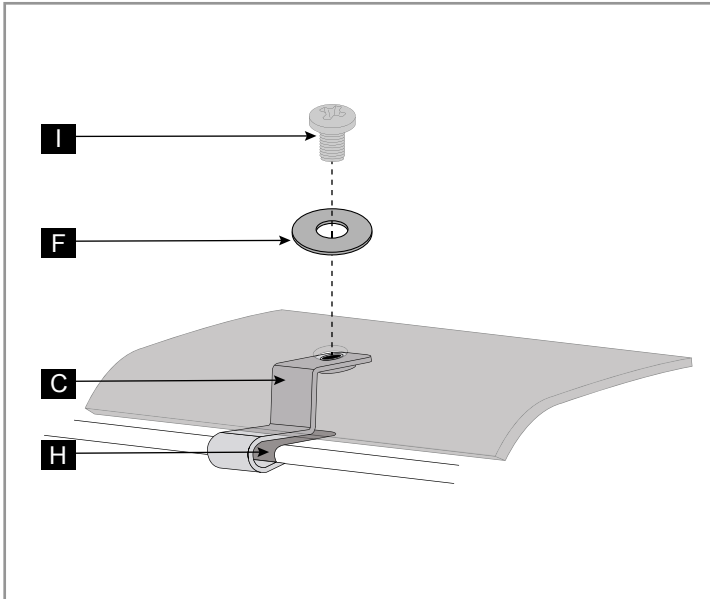

	#2 Phillips Screwdriver	<b>8</b>
<b>NOTE</b>	At the two (2) marked wing clip locations, install the two (2) wing clips "C". Locate the bottom leg of the clip over the abrasive resistant tape "H" then push into place. Make sure that the wing clips rest on the abrasive resistant tapes.	
	Ensure metal clips are positioned over abrasive resistant tape strips preventing direct contact to the paint. Failure to do so may result in permanent paint damage.	



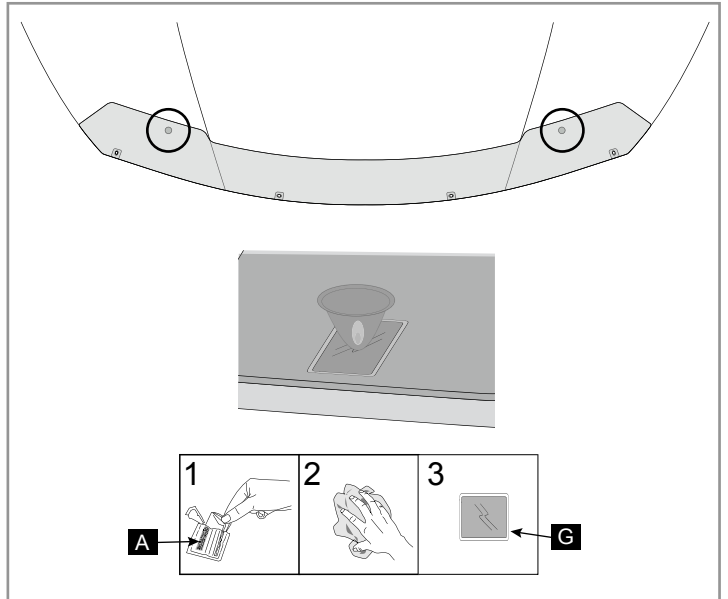

	#2 Phillips Screwdriver	<b>9</b>
<b>N O T E</b>	Loosely secure Hood Deflector to the top of metal wing clips "C" with the two (2) remaining small screws "I" and the two (2) remaining small washers "F" provided.	
	Only use moderate tension when securing the screws as to allow the hood deflector slight movement.	



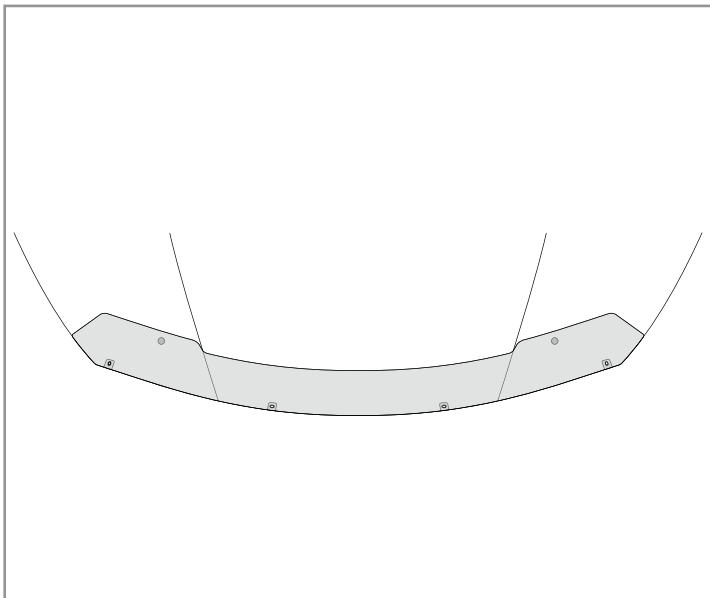



		<b>10</b>
<b>N O T E</b>	Clean the two (2) bumpon locations on the hood with the alcohol prep pad provided. Wipe off any residue with a dry clean cloth. Apply the small abrasive resistant tape "G" to the hood so that it is positioned under the bumpon.	
	Ensure center of small abrasive resistant tape strips are aligned between the bumpon and the hood to prevent contact between bumpon and painted surface of hood.	



	#2 Phillips Screwdriver	<b>11</b>
<b>N O T E</b>	Make sure Hood Deflector is centered then fully tighten all six (6) screws "I" and "J".	
		

## KIA Genuine Accessories

Items To Be Checked	Results of the Check
 Check the center fixed clips are over the abrasive resistant tapes. (Step 5)	Correct positioning.
 Check the wing clips are over the abrasive resistant tapes. (Step 8)	Correct positioning.
 Check bumpons are positioned over abrasive resistant tape strips (step 10)	Correct positioning.
 Do not over tighten screws. (Step 11)	Correct fitment.
 Check Hood Deflector to be centrally positioned. (Step 11)	Correct fitment.

**Cleaning Instructions**

Clean with a firm water spray to remove any loose dirt, then wash with water, detergent and a soft cloth or sponge. DO NOT use petroleum based solvents or abrasives.  
Remove Hood Deflector from the vehicle before using any car wash.

**Retain these instructions in your glovebox for future reference.**